

Front View

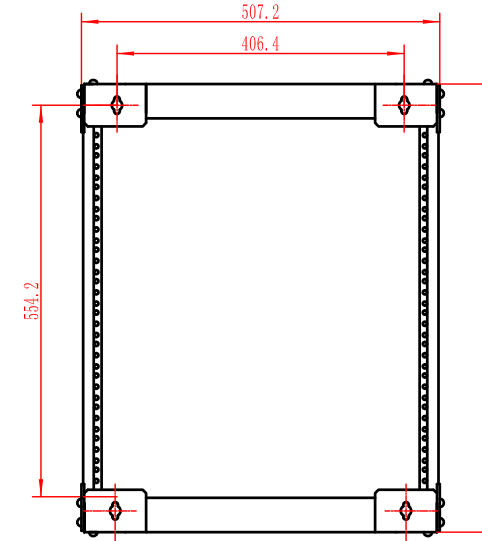

Back View

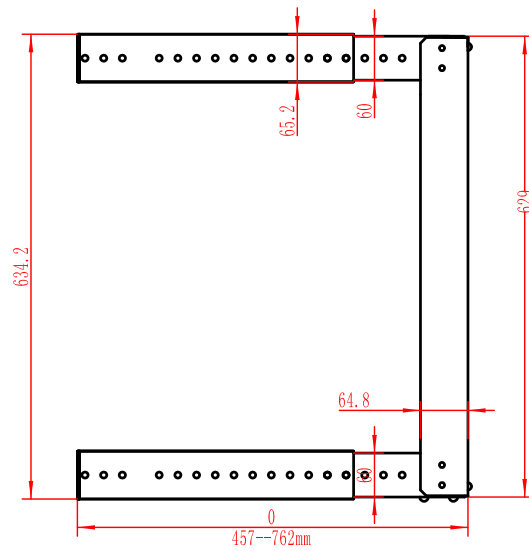

Side View

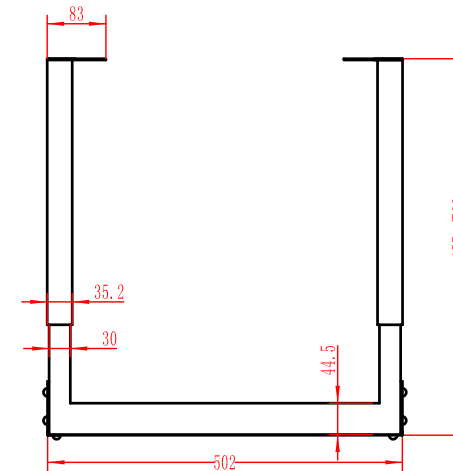

Top View

RoHS

Rack Unit: 12U
 Material: SPCC Cold Rolled Steel
 Thickness: 2mm
 Weight Capacity: 30KG (66lbs)

Part #	SO19J12WD4A	Part #	Rack Unit
Title	12U Wall Mount Rack Adjustable Depth	SO19J12WD4A	12U
Unit	 PI Manufacturing Corp.		
mm			