

SIDES	BOTTOM
Material: Steel-0.039"-G60 Galvanized	

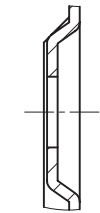

VIEW B



VIEW C

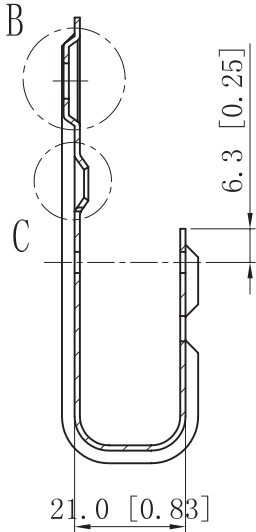

CUTAWAY VIEW A-A

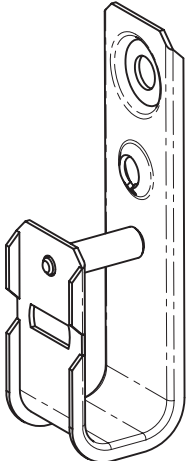
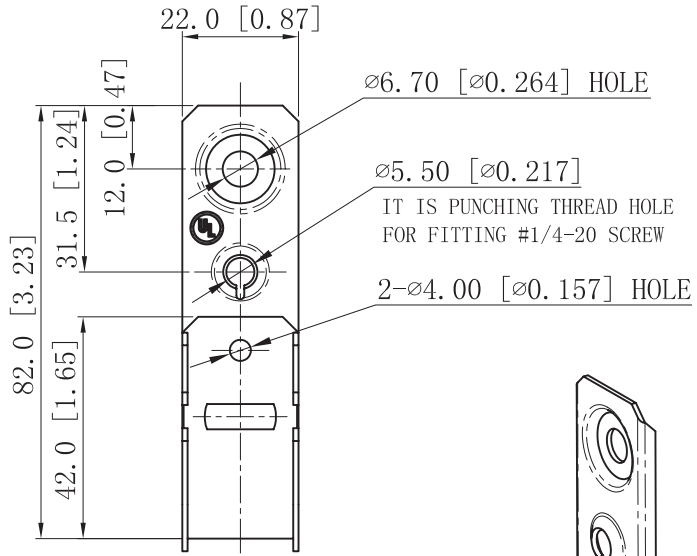
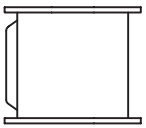
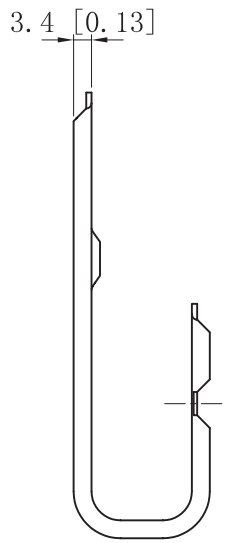
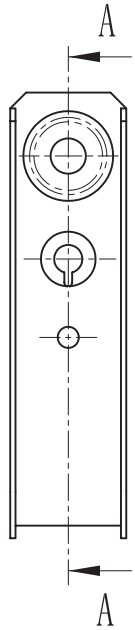

DESCRIPTION
TRADE REFERENCE TERMS

STANDARD PACKING

TITLE		J-HOOKS	
SIZE	DWG NO.	JH-34	REV
A4			B
DATA SHEET			